

Features

- Low Deviation in Base-Emitter Voltage
- Surface Mount Package
- Ideally Suited for Automated Assembly Processes
- **Lead Free by Design/RoHS Compliant (Note 1)**
- **"Green" Device (Note 2)**
- **Qualified to AEC-Q101 Standards for High Reliability**

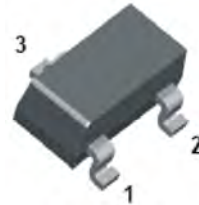

SOT-23

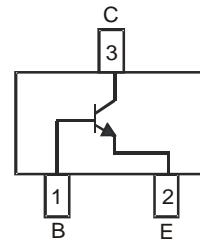

Schematic & Pin Configuration

Mechanical Data

- Case: SOT-23
- Case material: Molded Plastic. "Green" Molding Compound. UL Flammability Classification Rating 94V-0
- Moisture Sensitivity: Level 1 per J-STD-020D
- Terminal Connections: See Diagram
- Terminals: Finish - Matte Tin annealed over Alloy 42 leadframe. Solderable per MIL-STD-202, Method 208
- Marking Information: See Page 3
- Ordering Information: See Page 3
- Weight: 0.008 grams (approximate)

Maximum Ratings @_{T_A} = 25°C unless otherwise specified

Characteristic	Symbol	Value	Unit
Collector-Base Voltage	V _{CB0}	50	V
Collector-Emitter Voltage	V _{CE0}	45	V
Emitter-Base Voltage	V _{EBO}	6	V
Output Current - Continuous (Note 3)	I _C	200	mA
Peak Collector Current	I _{CM}	200	mA
Peak Emitter Current	I _{EM}	200	mA
Power Dissipation (Note 3)	P _d	300	mW
Power Deration	P _{der}	2.4	mW/°C

Thermal Characteristics

Characteristic	Symbol	Value	Unit
Thermal Resistance, Junction to Ambient Air (Note 3)	R _{θJA}	417	°C/W
Operating and Storage Junction Temperature Range	T _j , T _{STG}	-55 to +150	°C

- Notes:
1. No purposefully added lead.
 2. Diode's Inc.'s "Green" policy can be found on our website at http://www.diodes.com/products/lead_free/index.php.
 3. Device mounted on FR-4 PCB, 1 inch x 0.85 inch x 0.062 inch; pad layout as shown on page 4 or on Diodes Inc. suggested pad layout document AP02001, which can be found on our website at <http://www.diodes.com/datasheets/ap02001.pdf>.

Electrical Characteristics: NPN Transistor @ $T_A = 25^\circ\text{C}$ unless otherwise specified

Characteristic	Symbol	Min	Typ	Max	Unit	Test Condition
OFF CHARACTERISTICS (Note 4)						
Collector-Base Breakdown Voltage	$V_{(BR)CBO}$	50	—	—	V	$I_C = 10\mu\text{A}, I_E = 0$
Collector-Emitter Breakdown Voltage	$V_{(BR)CEO}$	45	—	—	V	$I_C = 1.0\text{mA}, I_B = 0$
Emitter-Base Breakdown Voltage	$V_{(BR)EBO}$	6	—	—	V	$I_E = 10\mu\text{A}, I_C = 0$
Collector Cutoff Current	I_{CEX}	—	—	15	nA	$V_{CE} = 50\text{V}, V_{EB(OFF)} = 3.0\text{V}$
Base Cutoff Current (I_{BEX})	I_{BL}	—	—	15	nA	$V_{CE} = 40\text{V}, V_{EB(OFF)} = 3.0\text{V}$
Collector-Base Cut Off Current	I_{CBO}	—	—	15	nA	$V_{CB} = 40\text{V}, I_E = 0$
				5	μA	$V_{CB} = 30\text{V}, T_A = 150^\circ\text{C}$
Collector-Emitter Cut Off Current, $I_{O(OFF)}$	I_{CEO}	—	—	50	nA	$V_{CE} = 40\text{V}, I_B = 0$
Emitter-Base Cut Off Current	I_{EBO}	—	—	50	nA	$V_{EB} = 5\text{V}, I_C = 0$
ON CHARACTERISTICS (Note 4)						
DC Current Gain	h_{FE}	180	—	—	—	$V_{CE} = 5\text{V}, I_C = 100\mu\text{A}$
		150	—	—	—	$V_{CE} = 5\text{V}, I_C = 500\mu\text{A}$
		220	—	—	—	$V_{CE} = 5\text{V}, I_C = 1\text{mA}$
		220	—	—	—	$V_{CE} = 5\text{V}, I_C = 2\text{mA}$
		150	—	—	—	$V_{CE} = 5\text{V}, I_C = 5\text{mA}$
		150	—	—	—	$V_{CE} = 5\text{V}, I_C = 10\text{mA}$
Collector-Emitter Saturation Voltage	$V_{CE(SAT)}$	—	0.09	0.18	V	$I_C = 10\text{mA}, I_B = 0.5\text{mA}$
		—	0.2	0.4	V	$I_C = 100\text{mA}, I_B = 5\text{mA}$
Base-Emitter Turn-On Voltage	$V_{BE(ON)}$	647	657	667	mV	$V_{CE} = 5\text{V}, I_C = 2\text{mA}$
Base-Emitter Saturation Voltage	$V_{BE(SAT)}$	—	—	0.8	V	$I_C = 10\text{mA}, I_B = 0.5\text{mA}$
		—	—	0.9	V	$I_C = 100\text{mA}, I_B = 5\text{mA}$
SMALL SIGNAL CHARACTERISTICS						
Output Capacitance	C_{OBO}	—	3	—	pF	$V_{CB} = 5.0\text{V}, f = 1.0\text{MHz}, I_E = 0$
Input Impedance	h_{ie}	—	4.5	—	K Ω	$V_{CE} = 5.0\text{V}, I_C = 2\text{mA}, f = 1.0\text{KHz}$
Voltage Feedback Ratio	h_{re}	—	2	—	$\times 10E-4$	
Small Signal Current Gain	h_{fe}	—	200	—	—	
Output Admittance	h_{oe}	—	30	—	μS	
Current Gain-Bandwidth Product	f_T	100	—	—	MHz	$V_{CE} = 20\text{V}, I_C = 10\text{mA}, f = 100\text{MHz}$
Noise Figure	NF	—	—	10	dB	$V_{CE} = 5\text{V}, I_C = 100\mu\text{A}, R_S = 1\text{K}\Omega, f = 1\text{kHz}$

Notes: 4. Short duration pulse test used to minimize self-heating effect.

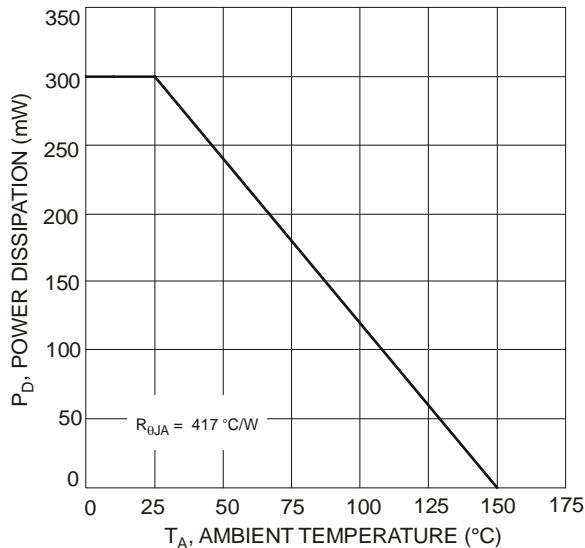

Fig. 1 Maximum Power Dissipation vs. Ambient Temperature

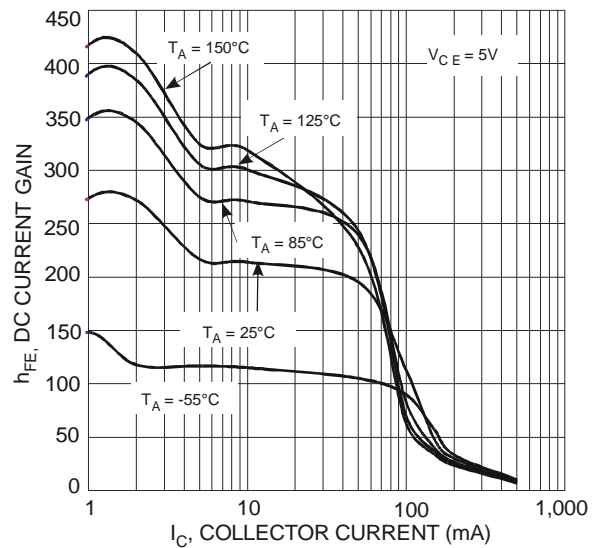

Fig. 2 Typical h_{FE} vs. I_C

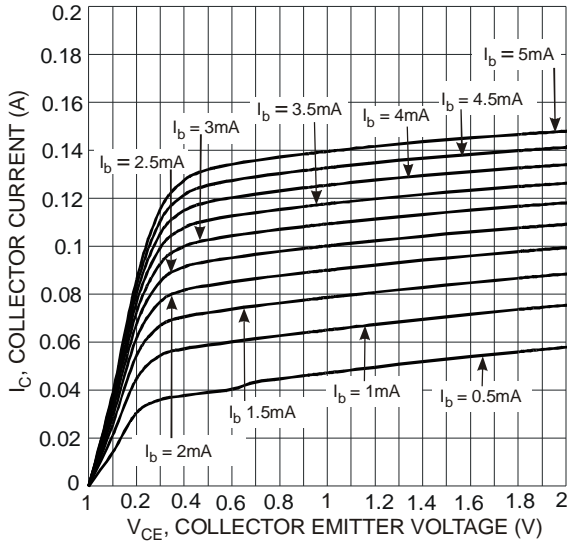

Fig. 3 Typical I_C vs. V_{CE}

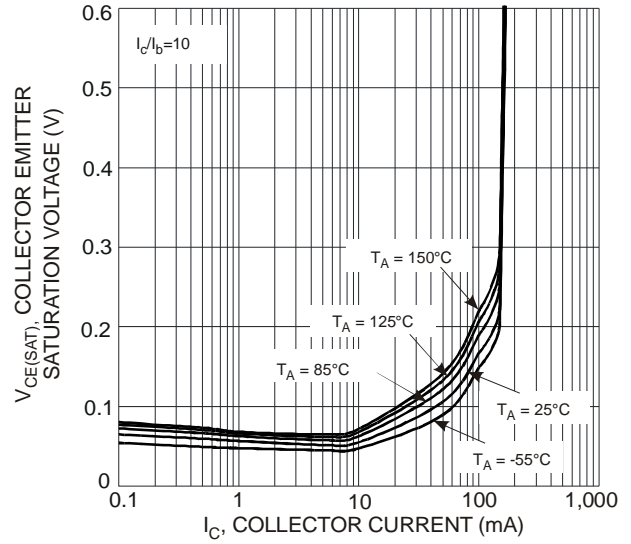

Fig. 4 Typical $V_{CE(SAT)}$ vs. I_C

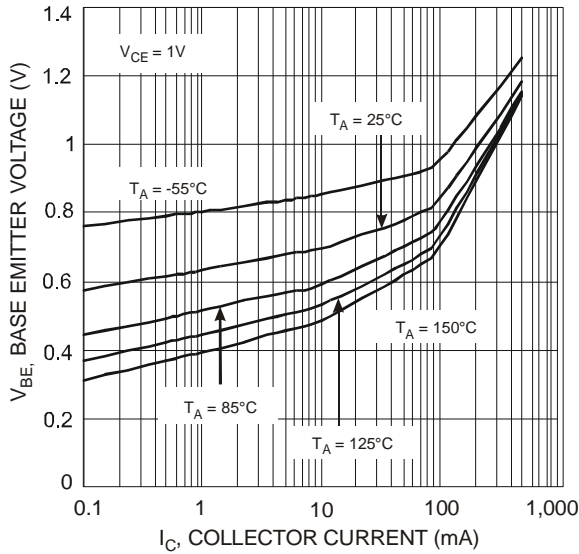

Fig. 5 Typical V_{BE} vs. I_C

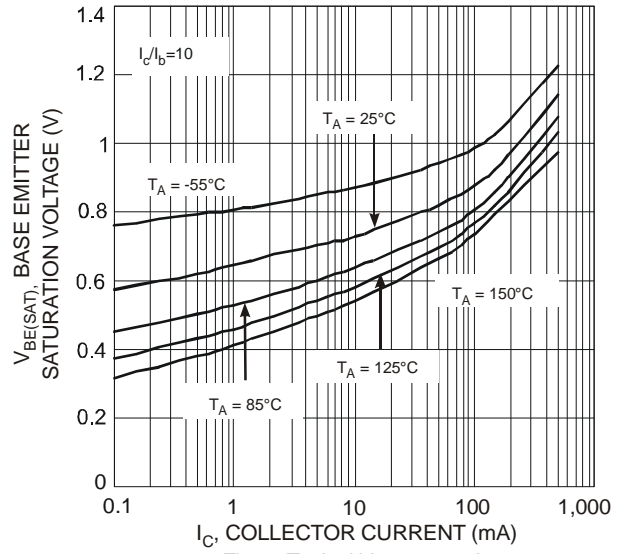

Fig. 6 Typical $V_{BE(SAT)}$ vs. I_C

Ordering Information (Note 5)

Device	Packaging	Shipping
BC847BLD-7	SOT-23	3000/Tape & Reel

Notes: 5. For packaging details, go to our website at <http://www.diodes.com/datasheets/ap02007.pdf>.

Marking Information

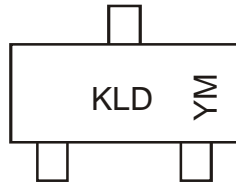

KLD = Product Type Marking Code
 YM = Date Code Marking
 Y = Year ex: T = 2006
 M = Month ex: 9 = September

Date Code Key

Year	2006	2007	2008	2009	2010	2011	2012	2013	2014	2015		
Code	T	U	V	W	X	Y	Z	A	B	C		
Month	Jan	Feb	Mar	Apr	May	Jun	Jul	Aug	Sep	Oct	Nov	Dec
Code	1	2	3	4	5	6	7	8	9	O	N	D

Mechanical Details

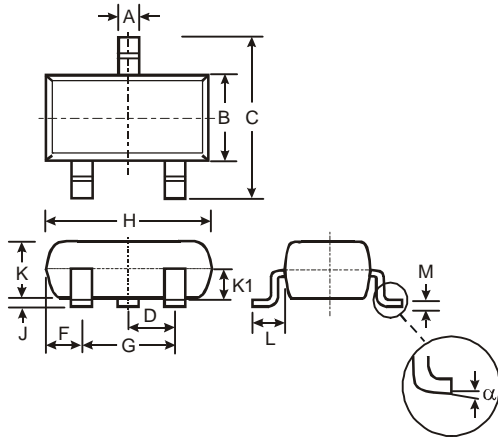

SOT-23			
Dim	Min	Max	Typ
A	0.37	0.51	0.40
B	1.20	1.40	1.30
C	2.30	2.50	2.40
D	0.89	1.03	0.915
F	0.45	0.60	0.535
G	1.78	2.05	1.83
H	2.80	3.00	2.90
J	0.013	0.10	0.05
K	0.903	1.10	1.00
K1	-	-	0.400
L	0.45	0.61	0.55
M	0.085	0.18	0.11
α	0°	8°	-
All Dimensions in mm			

Suggested Pad Layout

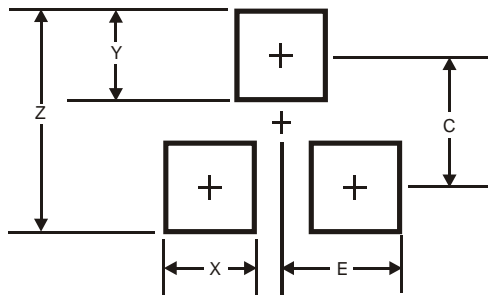

Dimensions	Value (in mm)
Z	2.9
X	0.8
Y	0.9
C	2.0
E	1.35

IMPORTANT NOTICE

Diodes Incorporated and its subsidiaries reserve the right to make modifications, enhancements, improvements, corrections or other changes without further notice to any product herein. Diodes Incorporated does not assume any liability arising out of the application or use of any product described herein; neither does it convey any license under its patent rights, nor the rights of others. The user of products in such applications shall assume all risks of such use and will agree to hold Diodes Incorporated and all the companies whose products are represented on our website, harmless against all damages.

LIFE SUPPORT

Diodes Incorporated products are not authorized for use as critical components in life support devices or systems without the expressed written approval of the President of Diodes Incorporated.